

General Safety Information

⚠ WARNING – To avoid serious injuries:

- Improper use of your bicycle's brake system may result in a loss of control or an accident, which could lead to a severe injury. Because each bicycle may handle differently, be sure to learn the proper braking technique (including brake lever pressure and bicycle control characteristics) for your bicycle. Consult your bicycle dealer and the bicycle's owners manual, and practice your riding and braking technique.
- Securely tighten the caliper brake mounting nuts to the specified tightening torque.
 - Use lock nuts with nylon inserts (self-locking nuts) for nut-type brakes.
 - For sunken nut type brakes, use sunken nuts of the appropriate length which can be turned six times or more; when re-installing, apply sealant (locking adhesive) to the nut threads.
- If the nuts become loose and the brakes fall off, they may get caught up in the bicycle and the bicycle may fall over. Particularly if this happens with the front wheel, the bicycle may be thrown forward and serious injury could result.
- Brakes designed for use as rear brakes should not be used as front brakes.
- **Obtain and read the service instructions carefully prior to installing the parts.** Loose, worn, or damaged parts may cause serious injury to the rider. We strongly recommend only using genuine Shimano replacement parts.
- Be careful not to allow any oil or grease to get onto the brake shoes. If any oil or grease do get on the shoes, you should replace the shoes, otherwise the brakes may not work correctly.
- Check the brake cable for rust and fraying, and replace the cable immediately if any such problems are found. If this is not done, the brakes may not work correctly.
- Always make sure that the front and rear brakes are working correctly before you ride the bicycle.
- The required braking distance will be longer during wet weather. Reduce your speed and apply the brakes early and gently.
- If the road surface is wet, the tires will skid more easily. If the tires skid, you may fall off the bicycle. To avoid this, reduce your speed and apply the brakes early and gently.
- Read these Technical Service Instructions carefully, and keep them in a safe place for later reference.

NOTE:

- If using SHIMANO's road brake shoes in combination with ceramic rims, the brake shoes will wear more quickly than normal.
- If the brake shoes have worn down until the grooves are no longer visible, they should be replaced.
- Parts are not guaranteed against natural wear or deterioration resulting from normal use.
- For maximum performance we highly recommend Shimano lubricants and maintenance products.
- For any questions regarding methods of handling or maintenance, please contact the place of purchase.

SI-8DD0A-001

BR-6600 Caliper Brake

Technical Service Instructions

In order to realize the best performance, we recommend that the following combination be used.

Series	ULTEGRA
Brake lever	ST-6600/BL-R600
Caliper Brake	BR-6600
Brake cable	

Installation of the brake lever

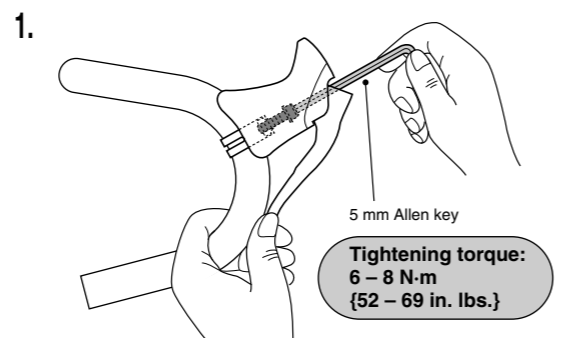

In the case of carbon handlebars, it may be necessary to lower the tightening torque in order to prevent damage to the handlebar. Please consult the bicycle or handlebar manufacturer regarding the appropriate level of tightening torque for carbon handlebars.

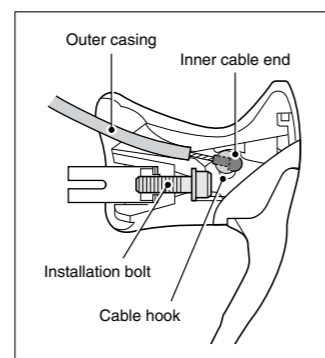
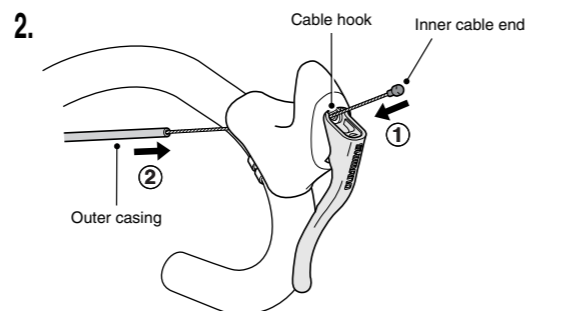

Checking the outer casing

Check to be sure that the outer casing has been completely and correctly inserted.

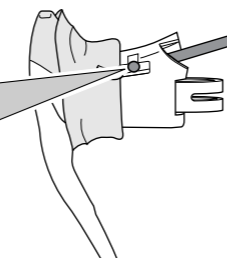

3. Temporarily secure the outer casing to the handlebar (by using tape or similar material).

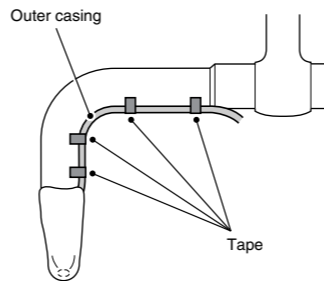

4. Then wrap the handlebar with handlebar tape.

Note:

- Cut the cable at the length at which it is not pulled tight when the handlebar is turned all the way to the left and right.
- If a squeaking noise occurs after a long period of use, lubricate the (A) parts.

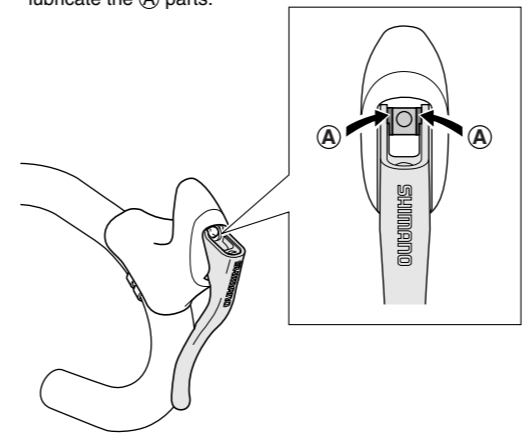

Installation of the brake

1. Installation of the brake itself

Compress the arch, and set while the shoe is in firm contact with the rim.

Tightening torque:
8 – 10 N·m {69 – 87 in. lbs.}

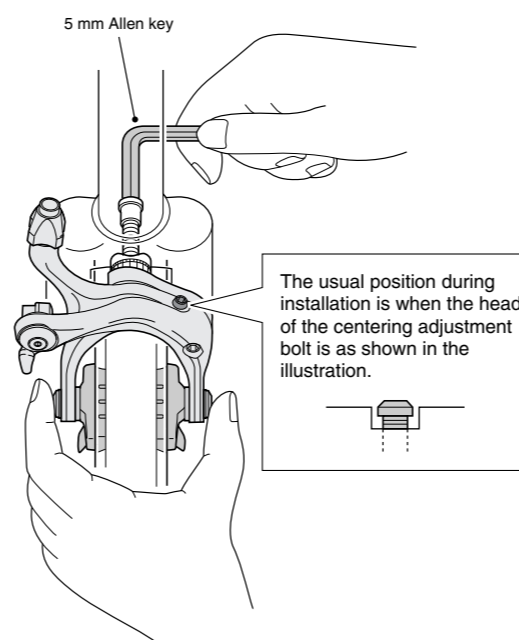

2. Brake shoe setting position

After adjusting the brake shoe position so that the shoe surface and the rim surface are as shown in the illustration, tighten the shoe fixing bolt.

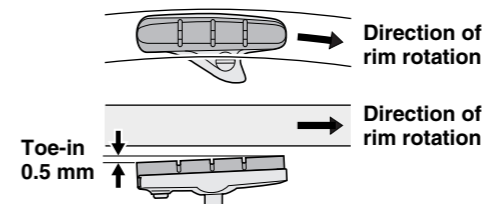

Note:

The BR-6600 allows the angle of contact between the shoe and the rim (toe-in) to be adjusted. Adjusting the toe-in makes it possible to obtain smoother braking operation.

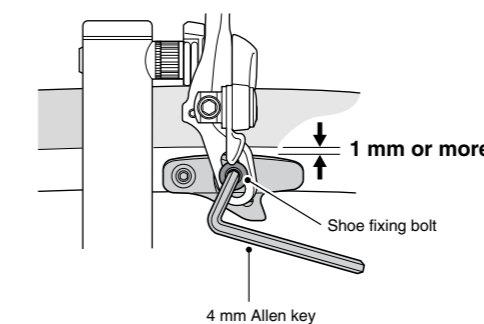

3. Cable connection

Set the quick release lever to the closed position; then adjust the shoe clearance (as shown in the illustration below) and secure the cable.

Cable bolt tightening torque:
6 – 8 N·m {52 – 69 in. lbs.}

4. Centering of the brake shoe

Make a minor adjustment by using the centering adjustment bolt.

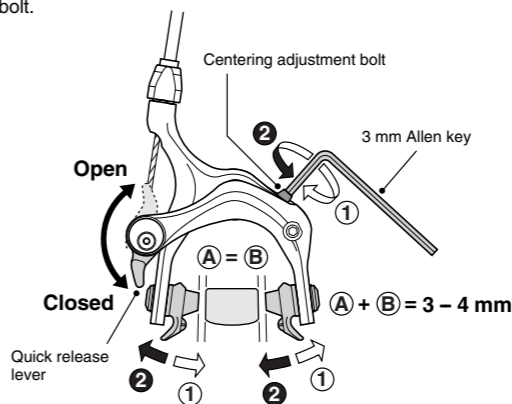

5. Readjustment of the shoe clearance

Turn the cable adjustment bolt to readjust the shoe clearance.

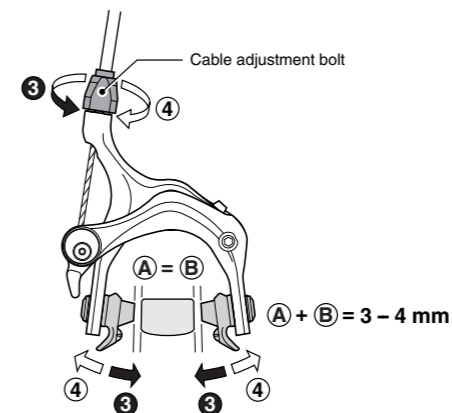

6. Check

Depress the brake lever about 10 times as far as the grip and check that everything is operating correctly and that the shoe clearance is correct before using the brakes.

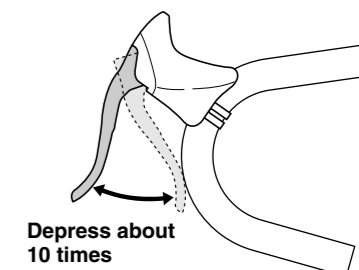

7. Arch spring tension adjustment

To increase the spring tension of the arch, hold the end of the spring with pliers and turn the sleeve around to face the other way.

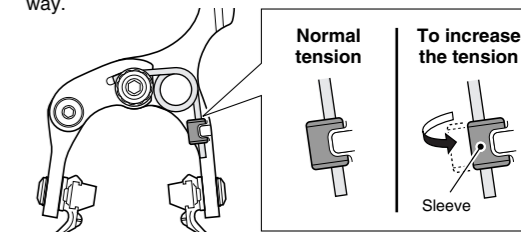

Replacement of the cartridge shoe

1. Remove the fixing bolt.

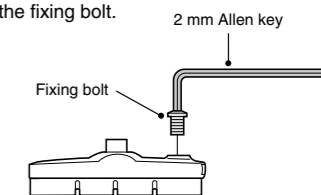

2. Remove the shoe by sliding it along the groove of the shoe holder.

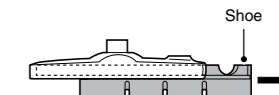

3. There are two different types of shoe and shoe holder to be used in the left and right positions respectively. Slide the new shoes into the grooves on the shoe holders while taking note of the correct directions and bolt hole positions.

For the left
Same at front and rear

For the right
Same at front and rear

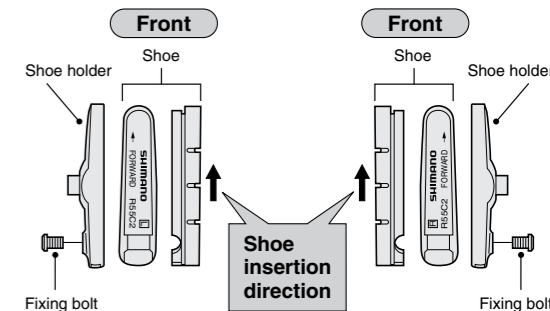

4. Tighten the fixing bolt.

Tightening torque: 1 – 1.5 N·m {9 – 13 in. lbs.}

These service instructions are printed on recycled paper. Please note: Specifications are subject to change for improvement without notice. (English)

SHIMANO

SHIMANO AMERICAN CORPORATION
One Holland, Irvine, California 92618, U.S.A. Phone: +1-949-951-5003

SHIMANO EUROPE B.V.
Industrieweg 24, 8071 CT Nunspeet, The Netherlands Phone: +31-341-272222

SHIMANO INC.
3-77 Oimatsu-cho, Sakai-ku, Sakai, Osaka 590-8577, Japan